



Make it your

# Home



2	Living room
12	Dining
16	Entertainment
24	Bedroom
30	Kids
34	Shelving
42	Storage
50	Home office

## The USM world

60	Strong core values
62	Product information
72	Colors & surfaces

Home is our personal retreat, the private space where we share special time with family and friends.

It is a reflection of our lifestyle, our attitudes and the things that mean the most to us. As our lives and tastes change, our home evolves with us – always in synch with our current needs.

USM Modular Furniture is designed to accompany us through different phases of life. It adjusts to new demands, ready to take up different functions in our home – a constant in our ever-shifting lives. On the following pages we present the diverse world of USM: from minimal to eclectic, from functional to decorative. Always modular and adjustable. Furniture for a lifetime made with great care in Switzerland.



**Online Configurator**  
Design your individual piece of USM online!



**Customized Service**  
Visit a USM Showroom or one of our 400 international sales partners worldwide for individual support. Find your closest USM professional online.

[www.usm.com](http://www.usm.com)

Living room

# It is simply about living your ideas, your style.

Make your home personal. Clear lines, versatile modularity: USM Haller lets you decide. Unobtrusive but essential, it adapts to your lifestyle, your changing needs, your personal taste. An enduring companion.





- 1 Sideboard  
W/D/H: 3023/373/740 mm  
with four drop-down doors

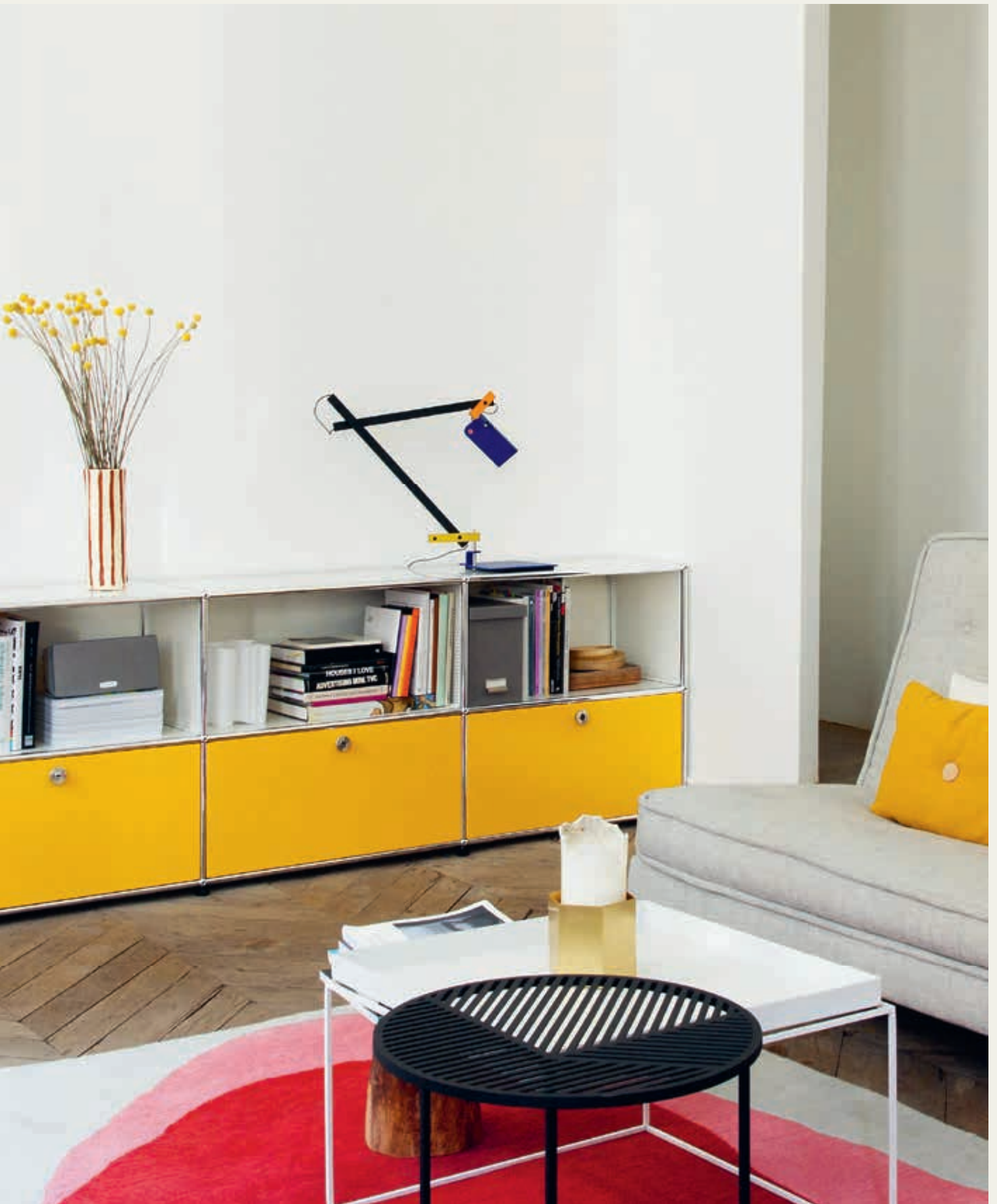

# Living room



↙  
 2 **Sideboard**  
 W/D/H: 2273/373/740 mm  
 with two drop-down doors  
 and three extension doors

→  
 3 **USM Haller E**  
**TV/HiFi unit\***  
 W/D/H: 1523/373/390 mm  
 with one drop-down door  
 and one cable cut-out  
 \*with a dimmable cold or  
 warm white light



4 **Sideboard**  
 W/D/H: 1523/373/740 mm  
 with four drop-down doors



5 **Sideboard**  
 W/D/H: 2273/373/740 mm  
 with two drop-down doors  
 and one extension door  
 with box insert



6 **Sideboard**  
 W/D/H: 3773/373/740 mm  
 with three drop-down doors  
 and three extension doors



# Living room



7 USM Haller E  
Glass showcase\*  
W/D/H: 773/523/1090 mm  
with three glass doors  
\* with a dimmable cold or  
warm white light

8 Glass showcase  
W/D/H: 3023/373/740 mm  
with eight glass doors

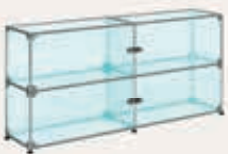

9 Glass showcase  
W/D/H: 1523/373/740 mm  
with four glass doors



10 USM Haller occasional  
table, square  
L/D/H: 750/750/370 mm  
Brown oiled oak veneer



11 Sideboard  
W/D/H: 1023/1023/540 mm



12 Side table  
W/D/H: 523/373/390 mm  
with one fixed shelf





# Living room



Create the colour combination of your dreams with our configurator.

↙  
13 Storage unit  
W/D/H: 2273/373/915 mm  
with six drop-down doors  
and three extension doors

↘  
14 Storage unit  
W/D/H: 2273/373/2490 mm  
with fifteen drop-down doors  
and six flip-up doors







# Living room

↓ 15 Sideboard  
W/D/H: 723/723/390 mm

↘ 16 USM Haller E  
Glass showcase\*  
W/D/H: 1523/373/1790 mm  
with three drop-down doors  
\* with a dimmable cold or  
warm white light

↘ 17 USM Haller occasional  
table, square  
L/D/H: 750/750/370 mm  
Transparent glass







Dining

# Sharing happiness with family and friends is priceless.

It is often little things that make life richer. Spending time with loved ones, eating, talking, laughing together. All it takes is a table to gather around. Pure and simple in design, the USM Haller Table allows you to dine in style.





↙  
 18 USM Haller table  
 Rectangular (combination)  
 L/D/H: 1500/1500/740 mm  
 Pure white powder-coated MDF

↙  
 19 Sideboard  
 W/D/H: 1523/373/565 mm  
 with two drop-down doors

→  
 20 Serving trolley  
 W/D/H: 773/523/580 mm  
 with a handle and casters



21 Sideboard  
 W/D/H: 1523/373/740 mm  
 with two drop-down doors



22 Sideboard  
 W/D/H: 2273/373/640 mm  
 with three drop-down doors



23 USM Haller table  
 Rectangular  
 L/D/H: 1750/750/740 mm  
 Pastel gray laminate



24 Serving trolley  
 W/D/H: 773/523/585 mm  
 with a handle and casters

# Dining

↙  
**25 Shelving**  
 W/D/H: 2273/373/1090 mm  
 with six drop-down doors

↘  
**26 USM Haller table**  
**Rectangular**  
 L/D/H: 1750/1000/740 mm  
 Steel blue, back lacquered  
 clear glass



**27 Shelving**  
 W/D/H: 1523/373/1090 mm  
 with four drop-down doors



**28 Shelving**  
 W/D/H: 2273/373/1315 mm  
 with seven drop-down doors  
 and two extension doors  
 with box insert



**29 USM Haller table Square**  
 L/D/H: 750/750/740 mm  
 Back-lacquered clear glass  
 Gentian blue

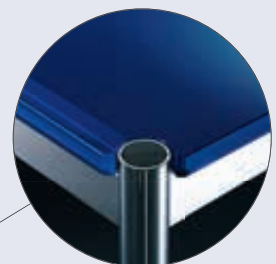

Classy Glass  
 Back-lacquered  
 glass tables are as  
 iconic as they are  
 durable and easy  
 to clean.





# Trends come and go while classic design is constant.

Clean in shape, honest in materialisation, timeless in design – USM Haller exists beyond trends. The beat of your life might change from time to time, another must-have home gadget might arrive. USM stays and adapts.





### 30 Sideboard

W/D/H: 3773/523/665 mm  
with five drop-down doors  
and five extension doors  
with box insert





# Entertainment



↙  
**31 Sideboard**  
 W/D/H: 2273/373/740 mm  
 with three extension doors

↙  
**32 Low TV/HiFi unit**  
 W/D/H: 1523/273/290 mm  
 with one drop-down door



**33 Sideboard**  
 W/D/H: 1523/373/565 mm  
 with four drop-down doors



**34 Sideboard**  
 W/D/H: 1523/373/740 mm  
 with two drop-down doors



**35 Low mobile TV/HiFi unit**  
 W/D/H: 1523/373/430 mm  
 with two divider shelves,  
 cable cut-out and casters



**36 Low mobile TV/HiFi unit**  
 W/D/H: 1523/373/430 mm  
 with two drawers,  
 counterweight and casters







37 Sideboard

W/D/H: 2023/523/740 mm  
with one drop-down door,  
one extension shelf,  
three extension doors  
and cable cut-out



# Entertainment

↙  
**38 Storage unit**  
 W/D/H: 1523/373/740 mm  
 with two drop-down doors

↘  
**39 Low mobile TV/HiFi unit**  
 W/D/H: 3023/523/430 mm  
 with four drop-down doors  
 and casters



**40 Sideboard**  
 W/D/H: 1523/373/565 mm  
 with two drop-down doors



**41 Low mobile TV/HiFi unit**  
 W/D/H: 1523/373/430 mm  
 with two drop-down doors  
 and casters



**42 Low TV/HiFi unit**  
 W/D/H: 2273/523/390 mm  
 with two drop-down doors,  
 one flip-up door  
 and one fixed shelf



**43 Side table**  
 W/D/H: 773/373/565 mm  
 with one drop-down door





## Bedroom

# Enjoy the peace and relax.

A bedroom is a place to relax, to recharge – your sanctuary. With its sheer simplicity, USM design helps you to ease your mind – offering enough variations to create your own personal sense of calm.





44 Storage unit  
W/D/H: 1873/373/390 mm  
with three drop-down doors



Would you like this piece of furniture to be wider, higher or lower? Configure your own furniture online.





# Bedroom

- ↙
**45 Side table**  
 W/D/H: 523/373/610 mm  
 with one drop-down door
- ↘
**46 Storage unit**  
 W/D/H: 2273/373/890 mm  
 with nine extension doors



Spacious drawers  
 Discover the full  
 range of smart  
 inner organizational  
 elements — p. 63.



**47 Storage unit**  
 W/D/H: 2273/523/565 mm  
 with three extension doors  
 and six A6 drawers



**48 Storage unit**  
 W/D/H: 1523/523/915 mm  
 with four A6 drawers  
 and six extension doors



**49 Storage unit**  
 W/D/H: 773/373/915 mm  
 with two drop-down doors,  
 two divider shelves and  
 one extension door







# Bedroom



↙  
 50 USM Haller E  
 Side table\*  
 W/D/H: 523/373/610 mm  
 with one drop-down door  
 \*with a dimmable cold or  
 warm white light

→  
 51 Side table  
 W/D/H: 418/523/540 mm  
 with one A6 drawer



USB chargers ensure that all mobile devices are powered 24 hours a day and transform the design classic into a charging station.



52 Side table  
 W/D/H: 773/373/840 mm  
 with two drop-down doors



53 Storage unit  
 W/D/H: 1023/373/565 mm  
 with two drop-down doors



54 Side table  
 W/D/H: 773/373/740 mm  
 with one drop-down door



55 Side table  
 W/D/H: 523/373/565 mm  
 with one drop-down door



Kids

# A playful start to grow into a great future.

Why not add a bit of color to your design? USM Haller marks a playful spot in your children's room. It serves as a toy box, a bookshelf or storage. A lifelong companion, growing with your children as their needs change.



↙  
56 Shelving  
W/D/H: 3273/373/2140 mm  
with ten drop-down doors

→  
57 Toy box  
W/D/H: 373/373/390 mm

↘  
58 Toy box  
W/D/H: 523/523/430 mm  
with casters



59 Desk with toy box  
W/D/H: 1273/523/580 mm  
with casters



60 Storage unit  
W/D/H: 1523/373/1090 mm  
with four drop-down doors



61 Low storage unit  
W/D/H: 2023/373/390 mm  
with four drop-down doors



Kids

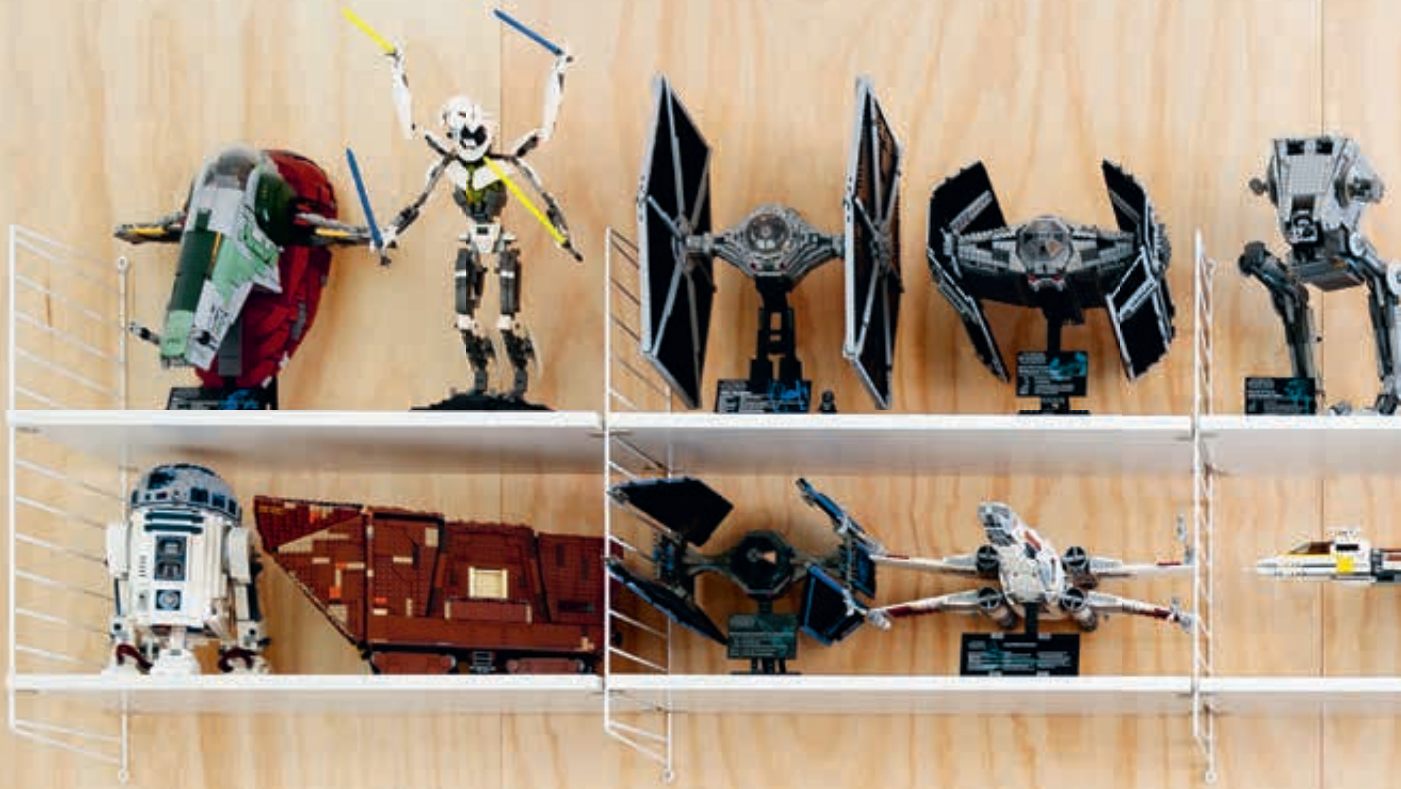

LEARN





62 Low mobile storage unit  
W/D/H: 3023/523/490 mm  
with four drop-down doors  
and casters





## Shelving

# Beauty and function from both sides.

Whether it's your library or a collection of anything you hold dear, make it accessible from both sides. USM Haller remains discreet, focusing all the attention on what you place on it – minimalist design at its very best.



63 USM Haller E  
Room divider\*  
W/D/H: 2523/373/1475 mm  
with seven drop-down doors  
and one glass door  
\*with a dimmable cold or  
warm white light





# Shelving

↙  
64 Room divider  
W/D/H: 1523/273/2990 mm  
with three drop-down doors

↙  
65 USM Haller occasional  
table, square  
L/D/H: 750/750/370 mm  
Back-lacquered  
clear glass, USM brown

→  
66 Shelving  
W/D/H: 2273/373/1940 mm  
with six drop-down doors







# Shelving





**67 Shelving**

W/D/H: 2273/373/1440 mm  
with three drop-down doors  
and three divider shelves



With our configurator you  
can playfully create your own  
individual furniture.



**68 Shelving**

W/D/H: 2273/373/2140 mm  
with two flip-up doors,  
four drop-down doors  
and three extension doors



**69 Shelving**

W/D/H: 3023/373/2140 mm  
with one drop-down door



**70 Shelving**

W/D/H: 3523/373/1790 mm  
with ten drop-down doors



**71 Shelving**

W/D/H: 3773/373/2140 mm



# Shelving



↙  
72 USM Haller E  
Glass showcase\*  
W/D/H: 3773/373/915 mm  
with ten glass doors  
\*with a dimmable cold or  
warm white light

↓  
73 USM Haller E  
Shelving\*  
W/D/H: 1873/473/3280 mm\*\*  
\* with a dimmable cold or  
warm white light  
\*\*This furniture has special dimensions,  
our sales partners will be happy to  
advise you

↓  
74 Side table  
W/D/H: 523/418/475 mm  
with casters





## Storage

# Our versatility with an unassuming face.

Thanks to its modularity and timelessness, USM fits into every environment, fulfilling a wide range of functions within your home. It adapts to your needs and taste. And it helps you organise your home, offering all the space you need – wherever you want it.



↙  
**75 Mobile pedestal**  
 W/D/H: 773/523/755 mm  
 with two drop-down doors  
 and one extension door  
 with box insert and casters

→  
**76 Shelving**  
 W/D/H: 523/373/1590 mm  
 with three extension doors  
 and box insert



Organizing trays  
 Discover the full  
 range of smart  
 accessories —  
 p. 63.



**77 Sideboard**  
 W/D/H: 1523/373/890 mm  
 with two extension doors  
 and counterweight



**78 Shelving**  
 W/D/H: 773/373/1090 mm  
 with three drop-down doors



**79 Mobile pedestal**  
 W/D/H: 523/373/605 mm  
 with three extension doors  
 with box insert and casters



# Storage



80 Glass showcase  
W/D/H: 1023/373/1740 mm  
with four drop-down doors  
and six glass doors



81 Sideboard  
W/D/H: 2273/723/890 mm  
with six drop-down doors  
without cover\*

\* Cover is not available  
in the USM standard range.



82 USM Haller E  
Glass showcase\*  
W/D/H: 1523/373/1440 mm  
with eight glass doors

\* with a dimmable cold or  
warm white light



83 Sideboard  
W/D/H: 1523/723/915 mm  
with six drop-down doors  
and six extension doors



84 Glass showcase  
W/D/H: 1023/373/1340 mm  
with two drop-down doors  
and two glass doors



85 Glass showcase  
W/D/H: 773/373/1440 mm  
with four glass doors







↙  
**86 Wardrobe**  
 W/D/H: 2273/723/1790 mm  
 with two drop-down doors,  
 two extension doors and  
 box insert, two flip-up doors,  
 and a clothes rail

→  
**87 Wardrobe**  
 W/D/H: 1273/523/1790 mm  
 with one flip-up door, three  
 extension doors and box insert,  
 one drop-down door, one  
 extension door, one fixed shelf,  
 a clothes rail and a pull handle



**88 Wardrobe**  
 W/D/H: 1523/523/1265 mm  
 with seven extension doors  
 with box insert and  
 a clothes rail



**89 Wardrobe**  
 W/D/H: 773/373/1915 mm  
 with two extension doors with  
 box insert and a clothes rail



**90 Wardrobe**  
 W/D/H: 2723/1473/1790 mm  
 with one drop-down door,  
 four extension shelves and  
 one extension door with box  
 insert and two divider shelves  
 and three clothes rails





# Storage



Design your individual piece of USM online!

↙  
91 **Wardrobe**  
W/D/H: 1523/373/1440 mm  
with three drop-down doors

↘  
92 **Shelving**  
W/D/H: 1023/373/815 mm  
with two drop-down doors





Home office

# Feel at home while you work at home.

The home office is a natural part of modern working life. An inspiring environment is not only stylish but enhances well-being and productivity. USM adds quality to the workplace in your home – and to your life at large.



### 93 Shelving

W/D/H: 3023/523/740 mm  
with five drop-down doors,  
two A6 drawers and one  
extension shelf





# Home office

↓  
94 **USM Haller E Shelving\***  
W/D/H: 773/373/1090 mm  
with two drop-down doors,  
one extension shelf and  
one fixed shelf

\*with a cold or warm white light  
on opening the compartment  
plus a USB charger

↓  
95 **USM Haller desk  
Rectangular**  
L/D/H: 1500/750/740 mm  
Pure white powder-coated MDF

↓  
96 **Mobile pedestal**  
W/D/H: 418/523/605 mm  
with three A6 drawers,  
with counterweight  
and casters



↓  
97 Shelving  
W/D/H: 3523/373/1790 mm  
with nine drop-down doors and  
four extension doors

↓  
98 USM Haller desk  
Rectangular  
L/D/H: 1500/750/740 mm  
Back-lacquered clear glass,  
pure white





# Home office



↙  
**99 Mobile pedestal**  
 W/D/H: 418/523/605 mm  
 with one A6 drawer and  
 one A4 drawer, with  
 counterweight and casters

→  
**100 Shelving**  
 W/D/H: 773/373/1090 mm  
 with two drop-down doors,  
 one extension door with box insert  
 and cable cut-out on the backwall



**101 Shelving**  
 W/D/H: 773/373/1790mm  
 with two drop-down doors



**102 Sideboard**  
 W/D/H: 1523/373/740mm  
 with two drop-down doors  
 and two extension doors  
 with filing frames



**103 Shelving**  
 W/D/H: 773/373/1440mm  
 with two drop-down doors



**104 Shelving**  
 W/D/H: 1273/523/740mm  
 with two drop-down doors



# Home office





**105 Shelving**

W/D/H: 3123/2623/2640 mm  
with six drop-down doors  
and six extension doors  
with filing frames



**106 USM Haller E Shelving\***

W/D/H: 2023/548/1090 mm  
with two drop-down doors,  
two extension doors  
and one extension shelf

\* with a dimmable light and a cold or warm white light on opening the compartment plus a USB charger



The golden yellow work and charging station boosts the energy in your home office. The barely visible lights and USB chargers embedded in the tubes can be disconnected and moved at any time.



Light when compartment is opened – sensor-controlled lights in drawers and compartments turn on automatically when opened.



**107 Shelving**

W/D/H: 1523/373/1090mm  
with four extension doors  
and filing frames



**108 Mobile pedestal**

W/D/H: 1023/373/605mm  
with four drop-down doors  
and casters



**109 Shelving**

W/D/H: 3523/373/1790 mm  
with thirteen drop-down doors

**110 USM Haller desk Rectangular**

L/D/H: 1500/750/740mm  
Pearl gray laminate



# Home office



111 USM Kitos M Plus desk  
L/D/H: 1750/750/700–1200 mm  
Pearl gray laminate

112 Mobile pedestal  
W/D/H: 418/523/605 mm  
with three A6 drawers,  
with counterweight and casters





Strong core

# values

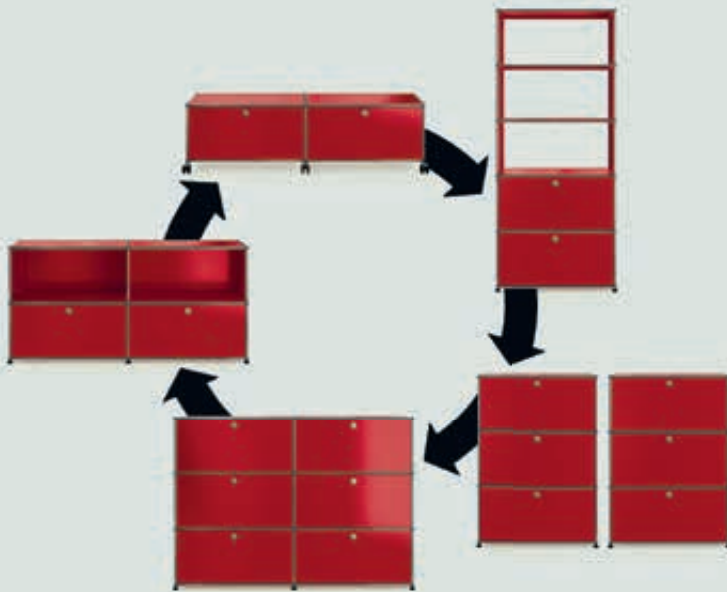

## Form follows you

Unlike many static design classics, celebrating individuality by adapting design and function to its user. For more than 50 years, flexibility, durability and consequently sustainability are core values of the USM brand. USM Modular Furniture is designed to be reconfigured – at any time.

## Sustainable concepts and actions

Developing solutions that respond to changing needs while remaining environmentally conscious has always been a USM philosophy. Since the beginning, and throughout USM's development, handling energy, emissions, materials and production methods in a responsible manner has been a key mission. In this regard, the longevity of USM products is of utmost importance. The longer the product can be used, the less impact it has on the environment. High-quality, durable materials, manufactured with the latest environmentally friendly technologies, guarantees a long, useful life for our product.



## Made in Switzerland

Founded in 1885, USM is a family business now in its fourth generation. «Made in Switzerland» to us is both a promise and an obligation. It stands for precision, quality, dependability, first-rate materials, careful workmanship and total commitment – on behalf of customer interest and out of respect for the environment.



Founded in 1885 and headquartered in Münsingen, Switzerland, USM today is still a family-owned and family-led business, now in its fourth generation.



## Worldwide services

USM provides trained specialists in furniture configuration, delivery and installation to ensure professional customer support. For USM assembly and repair, contact us directly or one of our 400 authorised sales partners in 40 countries, guaranteeing top-quality service around the world. Our modular system embodies dependability, and our customer service guarantees that you will receive quick, personalised answers to your questions. For customized advice, do not hesitate to visit our showrooms. USM has established a prominent reputation and international presence with flagship stores in Bern, Berlin, Düsseldorf, Hamburg, London, Munich, New York, Paris, Stuttgart and Tokyo that showcase local culture and offer technical support.



# USM Haller

The USM Haller system provides a wide variety of elements in standard sizes. Widths, depths and heights are indicated below. All measurements refer to the distance between axes.



Your safety matters to us. Check out the USM safety instructions now. [www.usm.com/safety](http://www.usm.com/safety)

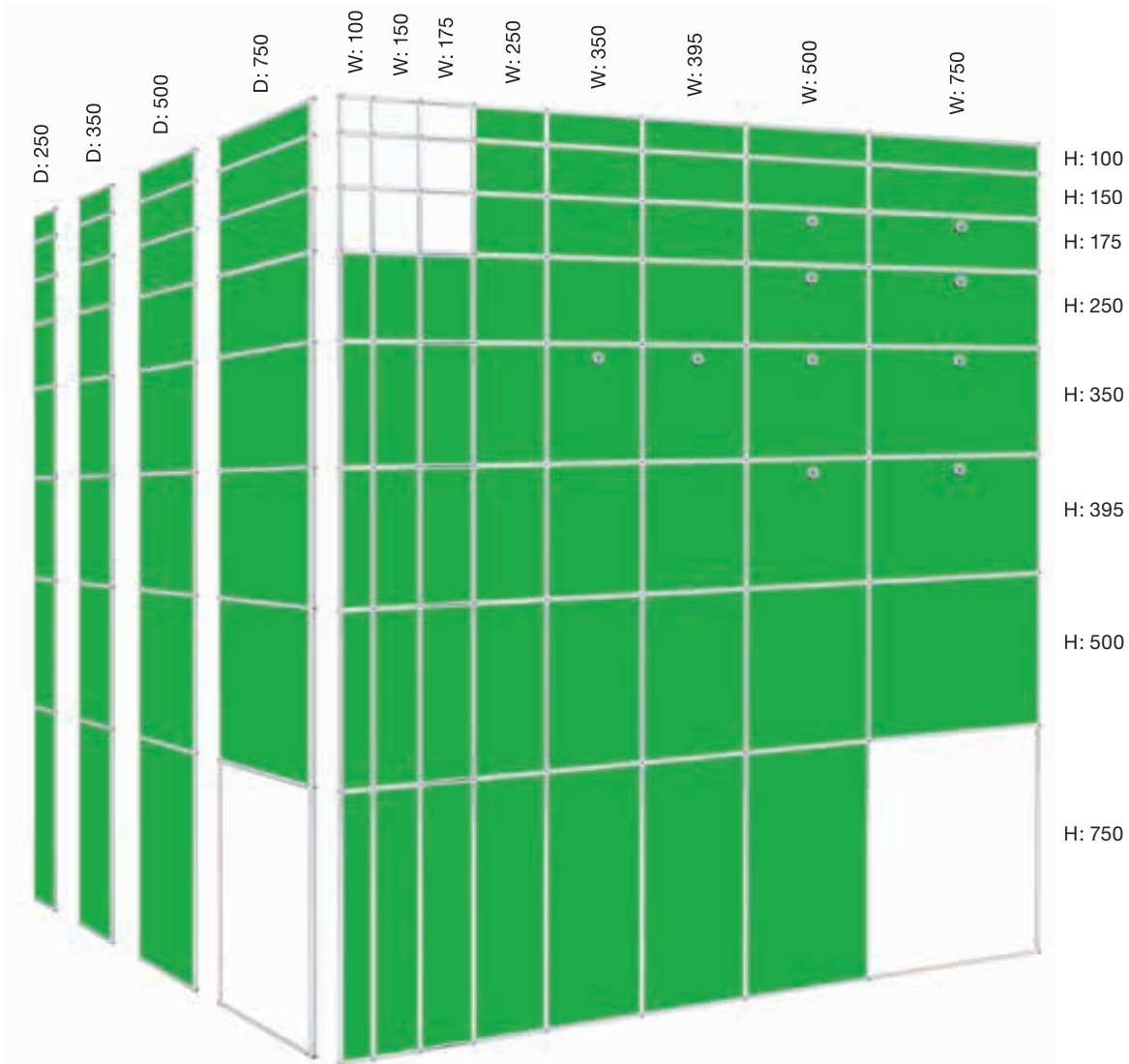
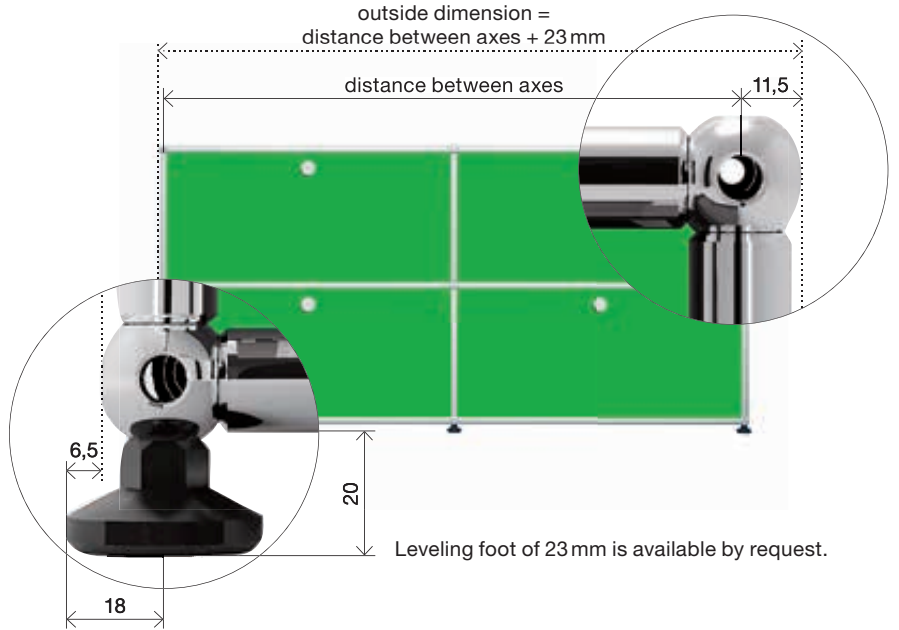

Panels

Doors

Shelves and drawers

Accessories

- 1 Metal panel
- 2 Glass panel
- 3 Acoustic panel
- 4 Perforated metal panel\*

- 5 Metal flip-up door\*
- 6 Glass door
- 7 Acoustic drop-down door\*
- 8 Metal drop-down door
- 9 Metal extension door\*

- 10 Metal divider shelf
- 11 Glass divider shelf
- 12 Metal extension shelf
- 13 Metal angled shelf
- 14 Extension filing set with extension shelf
- 15 Small drawer D: 500
- 16 A6 drawer D: 500
- 17 A5 drawer D: 500
- 18 A4 drawer D: 500
- 19 Extension filing set D: 500

- 20 Hanging file baskets
- 21 Metal box insert
- 21a Slide profile for metal box insert
- 22 Cable cut-out
- 23 Metal, magnetic bookend
- 24 USM Inos Box
- 25 USM Inos DVD tray
- 26 USM Inos CD tray

- 27 USM Inos angled file trays
- 28 USM Inos card box set
- 29 Bookend for bookshelf panel (D: 350)
- 30 USM Inos C4 box set, open
- 31 USM Inos C4 box set, closed
- 32 USM Inos drawer organizer set

Start configuring your individual piece of USM now!  
www.usm.com



\*Acoustic version available.  
USM Inos accessories are available in graphite black and light gray.

Illustration: USM Haller  
in D: 500 mm.  
All measurements in mm.



# USM Haller E

## Application Options

A modular structure of your design, either completely or partially equipped with e-Balls and e-Tubes, is connected to a source of electricity. The structure itself conducts the low voltage electricity to the desired location using the e-Balls, e-Connectors and e-Tubes to form a circuit. USB chargers or light sources can be snapped into place in pre-cut recesses. The power supply is drawn from any point near the ground. The power supply cable is attached to a Haller e-Ball, and the power adapter is subsequently tucked underneath the furniture until only the operating switch remains visible. From this point the power supply requires no further cables but rather is integrated into the structure of the furniture.

- 1 **Glass Panel**  
Glass elements can be illuminated throughout.
- 2 **Without Metal Paneling**  
Compartments without metal paneling can be completely illuminated.
- 3 **With Metal Paneling**  
Compartments with metal paneling can be illuminated from the front.
- 4 **Compartment with an Extension Shelf**  
The entire compartment with an extension shelf can be illuminated.
- 5 **Drop-Down and Extension Door**  
Via the "Light When Compartment Is Open" function, the light automatically turns on when the door is opened.
- 6 **Angled Shelf**  
The presentation space is illuminated from the front.
- 7 **Floor Lighting**  
With floor lighting, the light shines at a 25-degree angle under the furniture.
- 8 **Ambient Lighting**  
The light is directed vertically towards the back, illuminating the surroundings with a warm glow.
- 9 **e-USB Charger**  
It can be integrated in the same places as the e-Lights.



Winner of the German Design Award 2019 for outstanding design quality in the Office Furniture category



Winner of the Wallpaper Design Awards 2018



Winner of the Focus Gold Award 2018 for outstanding design quality



Winner of the Muuuz International Award 2018 in the furniture category



Winner of the FX Design Awards, Lighting Product 2017



## e-Elements

### 1 e-Lights

Dimmable, available in  
– Warm white  
2700 Kelvin  
– Cold white  
5700 Kelvin  
Both with or without the “light at compartment opening” function.

### 2 e-USB Charger

Provides a voltage of 5 volts to the connected device. (Capacity: 6.5 W)

### 3 e-Dummy

Sleek, black e-Dummy element close recesses that are still unutilised. If a piece of furniture should later be supplemented with additional light, using e-Tubes (consuming), which are first equipped with e-Dummy elements, is recommended.

### 4 e-Tube (power outlet)

Tubes with recesses for e-Lights, e-USB chargers or e-Dummy elements that can be easily snapped into place or replaced.

L 350, 1 recess  
L 500, 2 recesses  
L 750, 3 recesses

### 5 e-Tube (conductive)

The conductive e-Tube serves to conduct the electricity if no inserts are desired in this location. It is available in lengths of 750, 500, 395, 350, 250 and 175 mm.

### 6 e-Ball, e-Connector

To enable the flow of electricity, the ball and connector were refined. The exterior dimensions remain unchanged. The distinguishing feature of the ball is the black insulation ring.

### 7 e-Power Supply

Includes dimmer at the operating switch. Transforms the power supply voltage to 24 volts. (Capacity: 60 W)



Engineered & Made in Switzerland.

Only available in certain countries. Please contact USM Switzerland for availability in your country.





# USM Haller Table

Designed more than 50 years ago, the USM Haller Table still embodies timeless elegance. Its clean lines perfectly harmonise with the modular furniture system of the same name.

For home office use, the classic USM Haller Table is easily equipped with smart accessories and an optional cable basket as well as integrated solutions for electrification.

## Basic table

Optional cable basket underneath the tabletop



### USM Haller Classic

H: 740  
L: 3000 / D: 1000  
L: 3000 / D: 750  
L: 2500 / D: 1000  
L: 2500 / D: 750  
L: 2250 / D: 1000  
L: 2250 / D: 750  
L: 1000 / D: 1000  
L: 750 / D: 750

H: 740 or 680–860\*  
L: 2000 / D: 1000  
L: 2000 / D: 750  
L: 1750 / D: 1000  
L: 1750 / D: 750  
L: 1500 / D: 1000  
L: 1500 / D: 750  
L: 1250 / D: 750

## Sliding tabletop + adaptation points

Integrated cable tray accessible from above by sliding back the tabletop  
Adaptation points for accessories



### USM Haller Advanced

H: 740 or 680–860\*  
L: 2000 / D: 1000  
L: 2000 / D: 750  
L: 1750 / D: 1000  
L: 1750 / D: 750  
L: 1500 / D: 1000  
L: 1500 / D: 750  
L: 1250 / D: 750

## Working desk

Optional cable basket underneath the tabletop  
Removable adaptation points for accessories



### USM Haller Plus

H: 740  
L: 3000 / D: 1000  
L: 3000 / D: 750

H: 740 or 680–860\*  
L: 2000 / D: 1000  
L: 2000 / D: 750  
L: 1750 / D: 1000  
L: 1750 / D: 750  
L: 1500 / D: 1000  
L: 1500 / D: 750  
L: 1250 / D: 750

## Occasional table



### USM Haller occasional table, square

H: 370  
L: 3000 / D: 1000  
L: 3000 / D: 750  
L: 2500 / D: 1000  
L: 2500 / D: 750  
L: 2250 / D: 1000  
L: 2250 / D: 750  
L: 2000 / D: 1000  
L: 2000 / D: 750  
L: 1750 / D: 1000  
L: 1750 / D: 750  
L: 1500 / D: 1000  
L: 1500 / D: 750  
L: 1250 / D: 750  
L: 1000 / D: 1000  
L: 750 / D: 750

\*Manual height adjustment with a removable handle.  
All measurements in mm.

Accessories  
for all USM Haller Desks

- 1 **Grommet hatch for network access**  
Flush hinged cover set into the tabletop for easy network access, can be positioned at two different locations.
- 2 **Cable management**  
For the Advanced table type, a cable tray integrated under the tabletop offers storage room and attachment options for all cables and technical components.  
For the traditional USM Haller Table and the USM Haller Plus, a cable basket can be attached.
- 3 **CPU holder**  
Computers in various sizes can be mounted using a simple holding device under the table.
- 4 **Link chain**  
Holds and directs cables to the power source. Flexible and adjustable to various lengths.
- 5 **Power strip**  
Can be configured individually for data and power supply according to country-specific requirements. Available with a 4 m cable. Magnetically fixed in the cable tray.
- 6 **Flat screen pivot arm**  
Screens are screwed to the height adjustable pivot arm using a mounting plate (VESA standard). Available for USM Haller classic desk: The pivot arm can be mounted onto the table edges with the universal holder or into the table leg using an assembly tube. Available for USM Haller Plus and Advanced: The bracket can be connected directly to one of the adaptation points.
- Options  
6a **Mounting at different heights**  
is possible for screens weighing up to 12 kg.  
6b **Continuous height adjustment**  
for screens weighing up to 12 kg.

**Cable duct**

The classic USM Haller table can be updated with a black aluminum cable duct section, with lids that fold open on both sides, to integrate power strips (5) and cables. This enables the table depths to be expanded to the EU standard of more than 800 mm. For table heights of 2000, 1750, 1500, 1250, 1000, 900, 750.

Accessories  
for USM Haller Desk Plus/ Advanced

- 7 **Front and side panel**  
A black mesh fabric can be attached to the back or the side under the table frame. Available for the following table lengths: 2000, 1750, 1500, 1250, 1000, 750 and depths: 1000, 750.
- 8 **Material tray**  
Provides room for writing instruments and can be discreetly stowed under the tabletop.
- 9 **USM Privacy Panels**  
Can be attached to the long side to ensure individuality and privacy for people working at tables configured as a block station. H: 350 or 700. Available for the following table lengths: 3000, 2500, 2250, 2000, 1750, 1500, 1250\*  
\*only for Haller tables without Adaptation points
- 10 **Flat screen support bar**  
The bracket is inserted into the adaptation points. Up to two screens (max. 2 x 12 kg) can be attached using a mounting plate (VESA standard). Screens can be mounted at different heights; screens can be adjusted with ball joints.
- Options  
10a **Flat screen support bar fix**  
10b **Flat screen support bar adjustable**  
Move forwards or backwards 2 notches at a time to adjust the viewing distance.
- 11 **USB adapter**  
The adapter is suitable for USB 2.0 and 3.0 ports; it can easily be inserted into the adaptation point. Usable as power supply or for data transfer.
- 12 **Lamp peg**  
An optional lamp peg for easy attachment of traditional table lamps. Electrification is possible through the adaptation point.

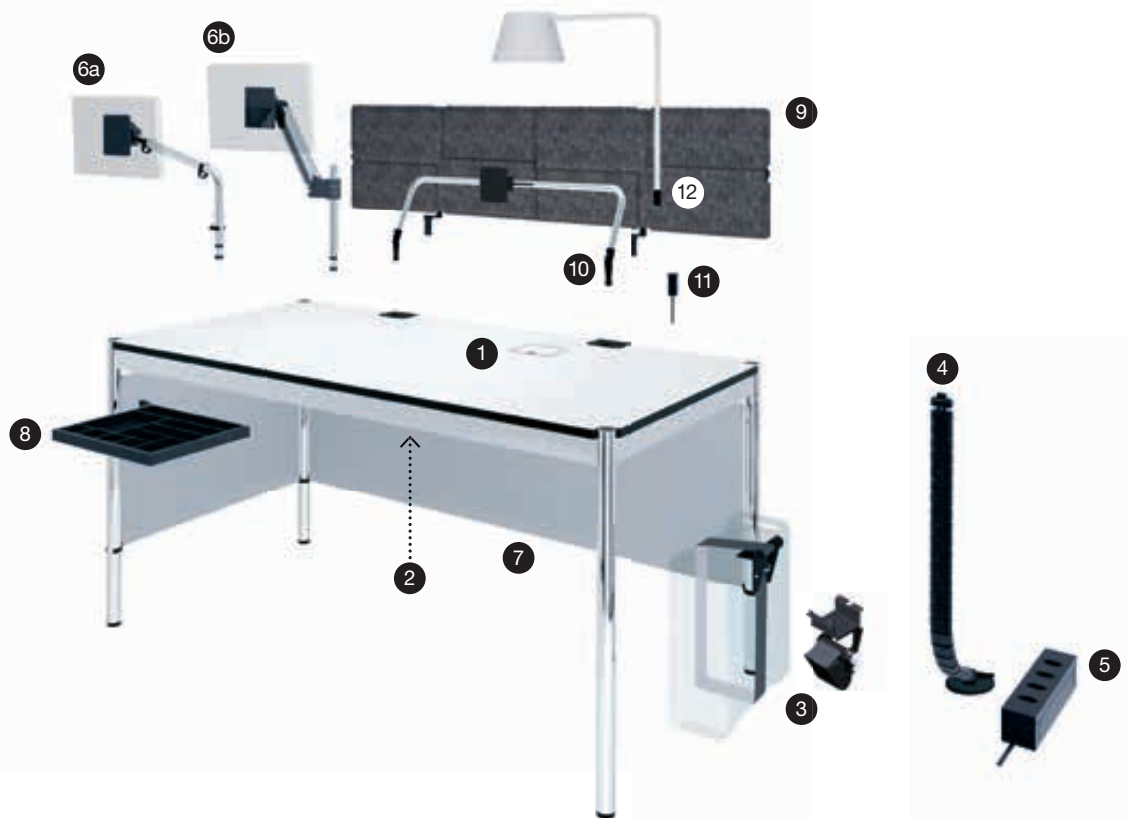



# USM Kitos M and E Desk

Each desk (except free-standing) of the USM Kitos M and E family offers integrated smart solutions for electrification.

## Why USM Kitos M?

The "M" in its name stands for mechanical spring-loaded height adjustment; adjustment time approx. 1 sec. with zero energy consumption. This system is more than 10 times faster than the electronic equivalent and has an extremely long operating life.

## Why USM Kitos E?

Maximum functionality and captivating design – USM Kitos E unites all requirements in one modern workplace: continuous height adjustability and maximum stability. A distinction is made between fixed and motor-driven legs in the E1, E2 and E3 models.

### E1



H: 740  
With or without middle traverse

### E2 with 1 motor



H: 700–1200  
Adjustment time approx. 30 sec.  
With middle traverse

### E3 with 2 motors



H: 650–1300  
Adjustment time approx. 20 sec.  
With middle traverse

## Basic desk

Integrated cable tray underneath the tabletop



### USM Kitos M

H: 700–1200  
L: 1800 / D: 900  
L: 1750 / D: 750  
L: 1600 / D: 800

### USM Kitos E

L: 1800 / D: 900  
L: 1750 / D: 750  
L: 1600 / D: 800  
Available with E1\*, E2 or E3\*\* columns

## Sliding tabletop

Integrated cable tray accessible from above by sliding back the tabletop

Adaptation points for accessories



### USM Kitos M Plus

H: 700–1200  
L: 1800 / D: 900  
L: 1750 / D: 750  
L: 1600 / D: 800

### USM Kitos E Plus

L: 1800 / D: 900  
L: 1750 / D: 750  
L: 1600 / D: 800  
Available with E1\*, E2 or E3 columns

## Extra size

Integrated cable tray underneath the tabletop and accessible from all sides



### USM Kitos M Meeting

H: 700–1150  
L: 2500 / D: 1000  
L: 2250 / D: 1000

### USM Kitos E Meeting

L: 2500 / D: 1250  
L: 2500 / D: 1000  
L: 2250 / D: 1000  
Available with E1, E2 or E3 columns

## Side table



### USM Kitos E Free-standing

H: 740 or 700 – 1110  
Square  
L: 750 and 900  
Round  
Ø: 900 and 1100

\* Available with or without middle traverse.

\*\*Available in a GS-Mark tested version with 3 mm table edge radius and the asymmetrical middle traverse.

The table can also be provided with an asymmetrical version of the middle traverse, for extra legroom. (This is not possible with the USM Kitos E / M Meeting.)

All measurements in mm.





# Accessories



1

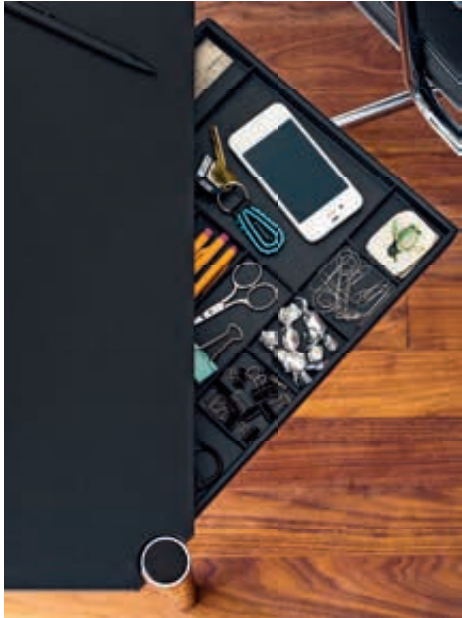

2



3



4

1 **Metal, magnetic bookend**  
Available in light gray and graphite black.

2 **Material tray**  
Provides room for writing instruments and can be discreetly stowed under the tabletop.

3 **USM Inos internal organisation**  
Plastic box in metal frame:  
Perfect for keeping small bits and pieces organized – be it in your home office or anywhere else in your house.

4 **USM Inos C4 box set**  
Available in light gray or graphite black, open or closed, with five or ten drawers: measurements of the Inos box set perfectly fit all USM Haller furniture.

5 **USM Inos Box**  
The new USM Inos Boxes organise, store and protect both your treasures and everyday paraphernalia of life. Several boxes can be stacked on top of each other with the help of trays, which can also be used as covers or serving trays, or to hold assorted small items around the home. These soft storage boxes made of nonwoven polyester are available in four different sizes and in light gray and anthracite gray.

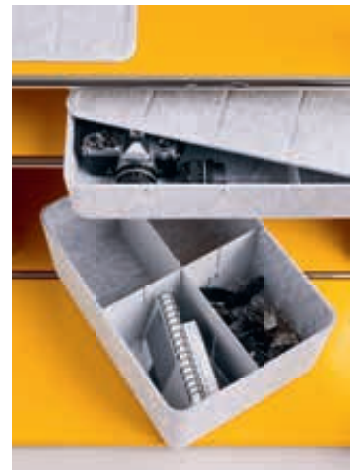

5



# Colors & surfaces

## USM Haller



### Metal



Pure white  
RAL 9010



Light gray  
RAL 7035



USM matte silver



Mid-gray  
RAL 7005



Anthracite  
RAL 7016

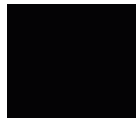

Graphite black  
RAL 9011



Steel blue  
RAL 5011



Gentian blue  
RAL 5010



USM green



Golden yellow  
RAL 1004



Pure orange  
RAL 2004



USM ruby red



USM brown



USM beige

## USM Haller and USM Kitos Tables



### Powder-coated MDF



Pure white  
RAL 9010

### Back-lacquered clear glass



Pure white  
RAL 9010



Light gray  
RAL 7035



USM matte silver



Mid-gray  
RAL 7005



Anthracite  
RAL 7016



Graphite black  
RAL 9011



Steel blue  
RAL 5011



Gentian blue  
RAL 5010



USM green



Golden yellow  
RAL 1004



Pure orange  
RAL 2004



USM ruby red



USM brown



USM beige

### Back-lacquered etched glass



Pure white  
RAL 9010



Light gray  
RAL 7035



Mid-gray  
RAL 7005



Anthracite  
RAL 7016



Graphite black  
RAL 9011



Steel blue  
RAL 5011

### Transparent glass



Transparent glass

Other colors and surfaces available upon request. Prices and delivery times of table surfaces upon request.

The tabletops in glass are only available for USM Haller Desks up to L: 2000 mm and all USM Kitos Desks with a fixed height (H: 740 mm) or stepwise height adjustment and continuous height adjustment (H: 680–780 / 1060 mm).

## Linoleum



Ash linoleum



Charcoal linoleum



Black linoleum



Pebble linoleum



Mauve linoleum

## Laminate



Pearl gray laminate



Pastel gray laminate



Light mid-gray laminate



Dark warm gray laminate

## Oiled or lacquered veneer



White oiled oak veneer



Natural oiled oak veneer



Brown oiled oak veneer



Natural lacquered oak veneer



Natural lacquered beech veneer



Black lacquered oak veneer

## Details

### USM Haller



Metal

### USM Haller Table



Powder-coated MDF

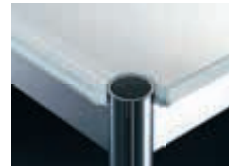

Back-lacquered clear glass

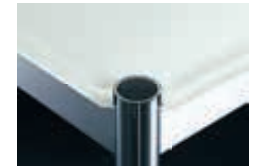

Back-lacquered etched glass

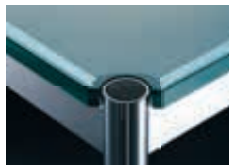

Transparent glass

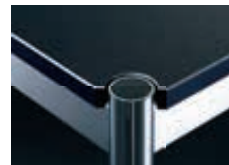

Linoleum



Laminate



Oiled or lacquered veneer

### USM Kitos Table



Powder-coated MDF

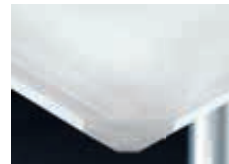

Back-lacquered clear glass



Back-lacquered etched glass



Transparent glass



Linoleum



Laminate



Oiled or lacquered veneer



## Switzerland

USM U. Schärer Söhne AG  
Thunstrasse 55, 3110 Münsingen  
Phone +41 31 720 72 72, info.ch@usm.com

## Germany

USM U. Schärer Söhne GmbH  
Siemensstraße 4a, 77815 Bühl  
Phone +49 7223 80 94 0, info.de@usm.com

## France

USM U. Schärer Fils SA, Showroom  
23, rue de Bourgogne, 75007 Paris  
Phone +33 1 53 59 30 37, info.fr@usm.com

## United Kingdom

USM U. Schaerer Sons Ltd., London Showroom  
Ground Floor, 49–51 Central St., London, EC1V 8AB  
Phone +44 207 183 3470, info.uk@usm.com

## USA

USM U. Schaerer Sons Inc., New York Showroom  
28–30 Greene Street, New York, NY 10013  
Phone +1 212 371 1230, info.us@usm.com

## Japan

USM U. Schaerer Sons K.K., Tokyo Showroom  
Marunouchi MY PLAZA 1 · 2F  
2-1-1 Marunouchi, Chiyoda-ku, Tokyo 100-0005  
Phone +81 3 5220 2221, info.jp@usm.com

All other countries  
contact USM Switzerland.

[www.usm.com](http://www.usm.com)